

LUXE

LUXE

MACHAN INTERNATIONAL CO., LTD.

No. 59-7, Shan-jiao Lane, Shui-mei Village,

Waipu, Taichung 43858, Taiwan

Tel: +886-4-2688-7171

Fax: +886-4-2688-5050

sales@ballida-medical.com

www.ballida-medical.com

CE ISO 9001:2000



LX SERIES

MEDICAL FURNITURE & HOSPITAL EQUIPMENT

Machan International Co., Ltd., is the parent company of BAILIDA and a manufacturer of professional tool storage units with a well earned international reputation for quality and service. For over 35 years we have been providing uniquely designed and high quality tool storage products to customers internationally. We are located in Taiwan, and were founded in 1976.

BAILIDA is our latest brand of hospital equipment. BAILIDA hospital equipment products include:

- Medical carts
- Medication carts
- Emergency / crash carts
- Utility trolleys
- Hospital equipment
- Hospital storage units and accessories

We also provide custom OEM/ODM services. BAILIDA is the transliteration of the Chinese meaning "100% of our best" for you. This is BAILIDA's essential spirit. And we take advantage of our strong Research and Development and Quality Management teams to provide you with OEM/ODM services and custom products.

BAILIDA is still young in the hospital equipment market but we are full of energy. In order to achieve 100% of our best, we leverage our creativity, efficiency, quality, stylish design and professional service to continually offer innovative and useful products.

Make BAILIDA your first choice for hospital equipment. Whether products or services, we promise to give you 100% of our best.

- 1 Features of the LX Series
- 3 Crash / Emergency Carts
- 5 Anesthesia Carts
- 7 Procedure Carts
- 9 Isolation Carts
- 11 File Carts
- 13 Accessory List
- 15 Divider System Package
- 17 Open Trolley Range
- 19 Bedside Cabinet



www.bailida-medical.com

100% of our best for you

FEATURES OF THE LX SERIES

Powder paint

4 main colours, other colour options available

- Anti-static paint available
- Anti-static and anti-bacterial paints available

You can choose more than just colours.
The cart can be a part of your stylish furniture.

- Wood grain design
- Garden & Sea sticker design for kids hospital

4 main colours

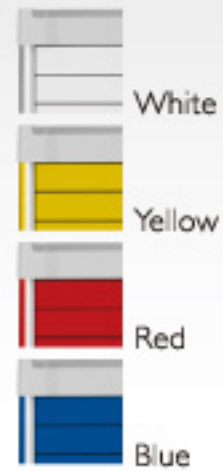

Other available colours



ABS top surface
Light, easy to clean.
Aluminium drawer handle



Aluminium push handle
User friendly design,
height adjustable, easy
set up.



Sliding table top extension
Easy to use, space
saving, max load 8kg



Central lock
secures all
drawers



MIS (Make It Safe)

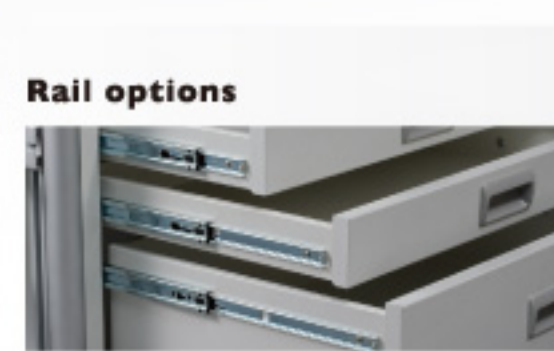

Auto return (standard)

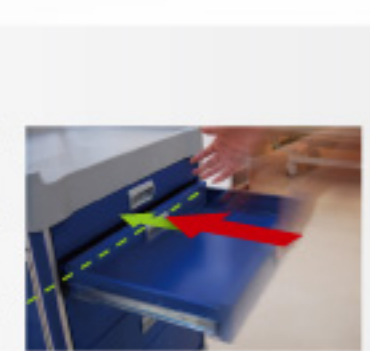

Soft return (light & quiet)

Rail options

Divider system
Clearly sorts and
organises medicines

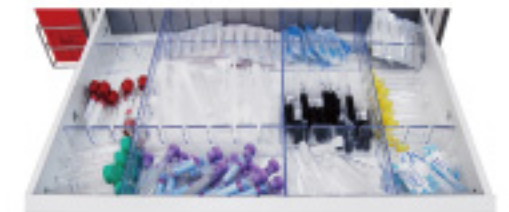

Side rail w/ knob

- Side rail can be fixed securely with adjustable knobs
- Height adjustable by turning knobs
- No special tools required when assembling accessories

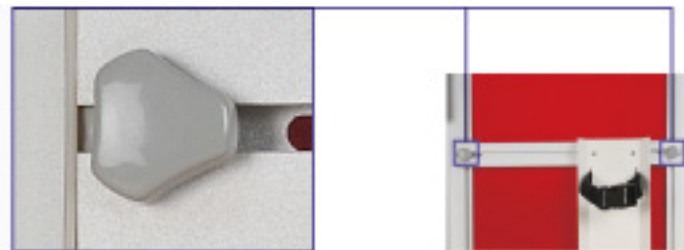

Caster options

Size: 5" (ø125mm)
Caster and drawer options are available to satisfy different customer requirements.



Twin wheel TPR caster



Plastic medical TPR caster (standard)



Dustproof medical TPR caster



Iron medical TPR caster

Drawer specifications

3 available cart heights: 31", 34", 37"
(w/o 5" Casters)

A Drawer
W569 x D398 x H76 (3")

B Drawer
W569 x D398 x H155 (6")

C Drawer
W569 x D398 x H234 (9")



CRASH / EMERGENCY CARTS



Garden sticker design for kids hospital

LX Emergency / Crash Carts were designed with input from emergency room professionals to deliver the ultimate in convenience and safety. These carts define a new standard of organization and function with specialised accessories for every emergency response. This series offers stable, smooth mobility and enhanced convenience with changeable accessories, as well as a breakaway lock for that little bit extra.



SPECIFICATIONS

	LX31EMG		LX34EMG		LX37EMG	
	mm	inch	mm	inch	mm	inch
W	690	27.2	690	27.2	690	27.2
D	540	21.3	540	21.3	540	21.3
H	930	36.6	1010	39.8	1090	42.9
H (w/o 5" Casters)	805	31.7	885	34.8	965	38



2 Defibrillator shelf is able to turn 360° and lock tight during transportation.

Breakaway lock 2 options



First drawer only



Locking bar

STANDARD ACCESSORIES

- 1 IV pole
- 2 Defibrillator shelf
- 3 CPR board
- 4 Oxygen tank holder
- 5 Sharps container set



CPR board
Macromolecular polymer CPR board is strong and easy to clean.



Oxygen tank holder
Adjustable ties securely fasten the oxygen tank.



Sharps container set

ANESTHESIA CARTS

LX Anesthesia Carts were designed with a combination of functions and technology specific to the needs of the anesthesia department. This series offers a wide choice of accessories to personalise carts for every possible situation. The top narcotics drawer locks to ensure medications are secure at all times.



SPECIFICATIONS

	LX31ANE		LX34ANE		LX37ANE	
	mm	inch	mm	inch	mm	inch
W	690	27.2	690	27.2	690	27.2
D	540	21.3	540	21.3	540	21.3
H	930	36.6	1010	39.8	1090	42.9
H (w/o 5" Casters)	805	31.7	885	34.8	965	38



STANDARD ACCESSORIES

- 1** IV pole
- 2** Tilt bin organisers (S)
- 3** Tilt bin organisers (L)
- 4** Accessory bridge
- 5** Glove dispenser
- 6** Sharps container set
- 7** Waste container w/ lid





PROCEDURE CARTS

LX Procedure Carts can be arranged to suit a multitude of medical departments & situations.

Supply and storage
Surgical
Castings
Dressings
Airways

Bio-medical
IV
Critical care
Trauma
Lab



SPECIFICATIONS

	LX31PRO		LX34PRO		LX37PRO	
	mm	inch	mm	inch	mm	inch
W	690	27.2	690	27.2	690	27.2
D	540	21.3	540	21.3	540	21.3
H	930	36.6	1010	39.8	1090	42.9
H (w/o 5" Casters)	805	31.7	885	34.8	965	38

STANDARD ACCESSORIES

- 1 IV pole
- 2 Multi storage (L)
- 3 Garbage bin w/ lid
- 4 Sharps container set



Multi storage (L)



Garbage bin w/ lid



Sharps container set



ISOLATION CARTS

LX Isolation Carts were designed with bright yellow drawers to alert staff and visitors. This series is available with non-locking drawers, central locking drawers, or individually locking drawers. Typical accessory options include deep drawers for bulky supplies (gowns, caps, gloves, etc.) and a built-in aluminium frame with yellow sign line.



SPECIFICATIONS

	LX3 ISO		LX34 ISO		LX37 ISO	
	mm	inch	mm	inch	mm	inch
W	690	27.2	690	27.2	690	27.2
D	540	21.3	540	21.3	540	21.3
H	930	36.6	1010	39.8	1090	42.9
H (w/o 5" Casters)	805	31.7	885	34.8	965	38



Drawers & dividers
Strong drawers with large storage capacity easily store large expendables and other supplies.

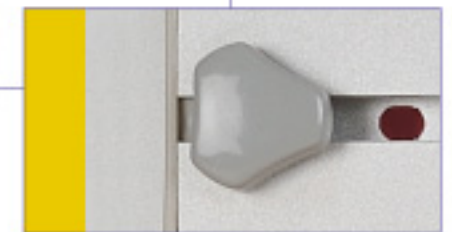

Side rail w/ knob

- Side rail can be fixed securely with adjustable knobs
- Height adjustable by turning knobs
- No special tool requires when assembling accessories

STANDARD ACCESSORIES

- 1 Multi storage (L)
- 2 Waste container w/ lid
- 3 Glove dispenser

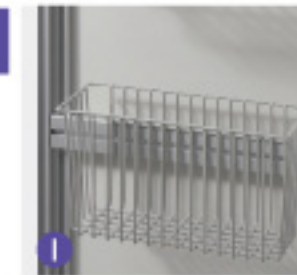

Multi storage (L)



Waste container w/ lid



Glove dispenser

FILE CARTS

LX File Carts were designed for efficient use, speedy delivery, and to fit different document sizes.



Features

- ABS top w/ sliding extension
- 12" high drawer x 2
- Central lock and key
- 5" TPR caster



Features

- ABS top w/ sliding extension
- 15" high door w/ handle
- 10 wire dividers
- 12" high drawer
- 5" TPR caster

Divider



Divider level adjusts to fit different document sizes.

SPECIFICATIONS

LX31FDT

	mm	inch
W	690	27.2
D	540	21.3
H	930	36.6
H (w/o 5" Casters)	805	31.7

Drawer

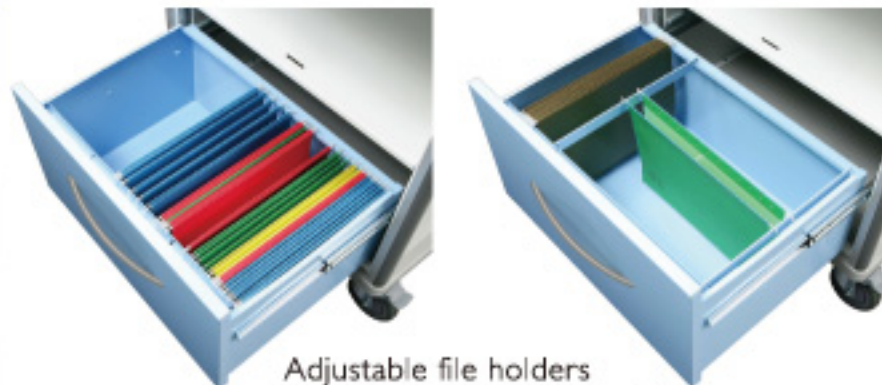

Adjustable file holders can be set at different positions.

SPECIFICATIONS

LX34FDT

	mm	inch
W	690	27.2
D	540	21.3
H	1010	39.8
H (w/o 5" Casters)	885	34.8



Locking door keeps documents secure

ACCESSORY LIST

Top accessories



VIV
IV pole



VDS
Defibrillator shelf
355 x 355 x 415mm



VTB-2
Tilt bin organiser (S)
600 x 111 x 230mm



VTB-1
Tilt bin organiser (L)
600 x 161 x 168mm



P-AB
Accessory bridge
800mm



VBS-1 & VPR-1
Bulk storage bins (L)
& back rail
75 x 105 x 190mm



VGD & VPR-1
Glove dispenser &
back rail
160 x 135 x 95mm



VBH & VPR-1
Bottle holder &
back rail
355 x 95 x 80mm

Rear accessories



VCPR & VHK
CPR cardiac board &
hooks
440 x 510 x 10mm



VMH
Magnetic label holder
L80 x W50 x T5mm
6pcs/pack



VPT
Pull-tite seal in pink
w/ serial no., 50pcs/pack



VPS
Plastic seal
w/ serial no., 50pcs/pack

Others



Side rail w/ knob

- Side rail can be fixed securely with adjustable knobs
- Height adjustable by turning knobs
- No special tools required when assembling accessories

Side accessories



VGD & VPR-2
Glove dispenser &
side rail



VSC & VPR-2
Sharps container &
side rail



VBH & VPR-2
Bottle holder &
side rail

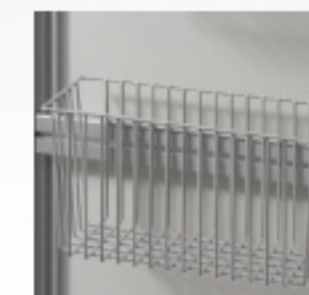

VMS & VPR-2
Multi-storage (L) &
side rail



VWC & VPR-2
Waste container w/ lid &
side rail
255 x 170 x 315mm



VWB & VPR-2
Waste bin & side rail
265 x 255 x 460mm



VGB & VPR-2
Garbage bin & side rail
255 x 170 x 315mm



VFH & VPR-2
File holder & side rail
571 x 397 x 150mm



VO2 & VPR-2
Oxygen tank holder &
side rail
145 x 125 x 403mm



VCH & VPR-2
Catheter holder &
side rail
100 x 100 x 480mm











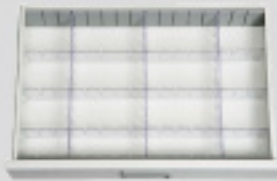
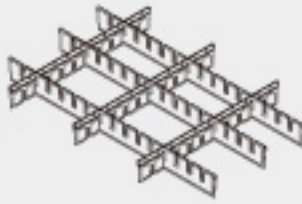

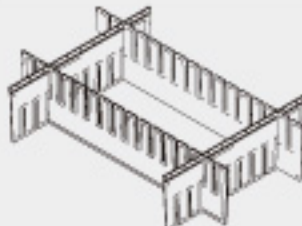

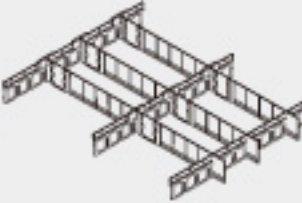
VSH & VPR-2
Suction machine holder &
side rail
213 x 395 x 115mm

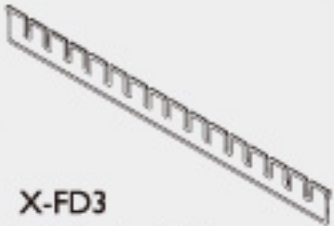
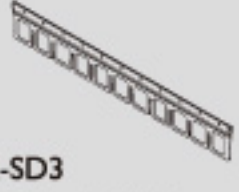

VDH & VPR-2
Documents holder &
side rail
330 x 160 x 255mm

DIVIDER SYSTEM PACKAGE

Fixed divider set			
 <p>P-FD3</p>	<p>3" fixed divider set in drawer (3 x short + 3 x fixed + 2 x 3" strip)</p>	 <p>P-FT3</p>	<p>3" fixed divider set (3 x short + 3 x fixed)</p>
 <p>P-FD6</p>	<p>6" fixed divider set in drawer (2 x short + 2 x fixed + 2 x 6" strip)</p>	 <p>P-FT6</p>	<p>6" fixed divider set (2 x short + 2 x fixed)</p>
Adjustable divider set (Length adjustable)			
 <p>P-AD3</p>	<p>3" adjustable divider set in drawer (3 x short + 6 x adjustable + 2 x 3" strip + 6 x T clips)</p>	 <p>P-AT3</p>	<p>3" adjustable divider set (3 x short + 6 x adjustable + 6 x T clips)</p>
 <p>P-AD6</p>	<p>6" adjustable divider set in drawer (3 x short + 4 x adjustable + 2 x 6" strip + 4 x T clips)</p>	 <p>P-AT6</p>	<p>6" adjustable divider set (3 x short + 4 x adjustable + 4 x T clips)</p>

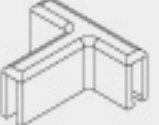
3" Individual divider			
 <p>X-FD3 3" Fixed divider 542 x 51 x 4.6mm</p>	 <p>X-SD3 3" Short divider 368 x 51 x 4.6mm</p>	 <p>X-AD3 3" Adjustable divider 237 x 51 x 5.3mm</p>	 <p>X-LH Label holder 40 x 60 x 18mm 20 pcs/pack</p>
6" Individual divider			
 <p>X-FD6 6" Fixed divider 542 x 130 x 4.6mm</p>	 <p>X-SD6 6" Short divider 368 x 130 x 4.6mm</p>	 <p>X-AD6 6" Adjustable divider 237 x 130 x 5.3mm</p>	 <p>XTC T clip 40 x 36 x 17.5mm 10 pcs/pack</p>

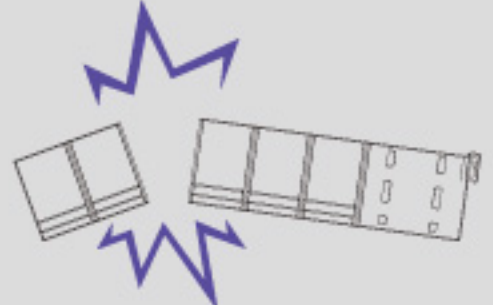

The length of the adjustable divider can be changed with a snap.

After snapping, the length of the adjustable divider cannot restore to the original.

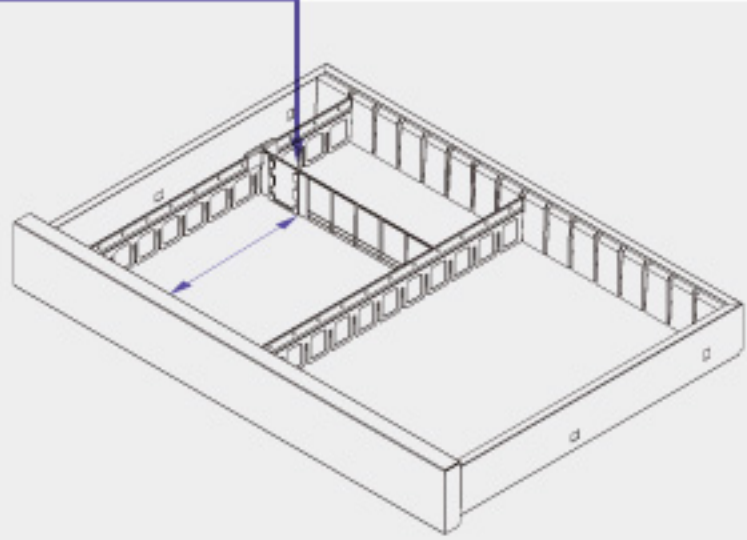

OPEN TROLLEY RANGE

Bailida open trolley range was designed for use in clean designated areas and for medicine transportation. Different accessories can be assembled on both sides of the trolley. This range is available with white frames, 3" & 6" blue ABS trays, and single or double columns at different trolley heights. The bumper design protects the user and the trolley well.

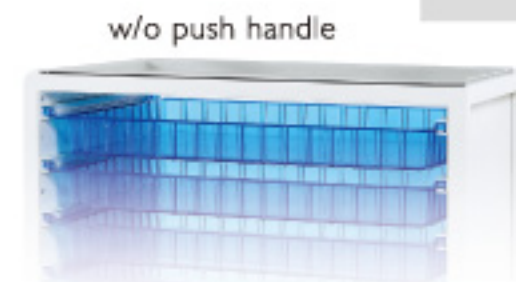

ABS trays

- 3" & 6" are available.
- Trays can be pulled out from both sides.
- Divider system clearly sorts medicines in ABS trays.



SPECIFICATIONS	OT-S1 (w/o push handle)		OT-S2 (w/ push handle)		OT-S3 (w/o push handle)		OT-D1 (w/o push handle)		OT-D2 (w/ push handle)		OT-D3 (w/o push handle)	
	mm	inch	mm	inch	mm	inch	mm	inch	mm	inch	mm	inch
W	659.2	26	659.2	26	659.2	26	891	35.1	891	35.1	891	35.1
D	406	16	406	16	406	16	606	23.9	606	23.9	606	23.9
H	822	32.4	1070	42.1	1454	57.2	822	32.4	1070	42.1	1454	57.2
H (w/o 4" Casters)	664.5	26.2	912.5	35.9	1296.5	51	664.5	26.2	912.5	35.9	1296.5	51

BEDSIDE CABINET



Features

- ABS body, top & drawer
- 2" plastic casters



BC35GR



Features

- Metal powder coated body
- ABS top, sliding work surface
- Single drawer with key lock
- Recessed front facing w/ one adjustable layer inside for storage
- Stainless towel holders on both sides
- Available colours: light pink / light blue
- Other colours: available with MOQ
- 2" plastic casters

BC30PL



BC37BL



SPECIFICATIONS

	BC30PL		BC35GR		BC37BL	
	mm	inch	mm	inch	mm	inch
W	460	18.1	460	18.1	460	18.1
D	508	20	460	18.1	508	20
H (w/ 2" Casters)	760	29.9	870	34.3	930	36.6